

Kahler®
MADE IN USA

BRIDGE SYSTEMS

Lifetime Guaranteed Knife Edge Bolts

Kahler® guarantees the knife edge bolts to stay sharp for the life of the tremolo. (Please refer to instructions to "Dial-in" sharp edges when necessary) Kahler® agrees to replace any knife edge bolts when a sharp edge cannot be "Dialed-in" (see instructions) for a \$2.00 handling charge.

Precision Manufacturing

At Kahler®, QUALITY is the product of teamwork. Engineers, technicians, craftsmen, sales, and customer service personnel all contribute in their own way to the production of the finest precision manufactured musical instrument accessories in the world. Our goal is to satisfy each and every customer. Kahler® is proud of its proven record of professional service, highest quality workmanship, and its "MADE IN USA" imprint on all products manufactured.

Computerized Systems

Our computerized inventory processing system offers unique customer advantages not found in ordinary manufacturing facilities. Developed and perfected exclusively by Kahler®, this technology assures systematic scheduling, provides vital lead-time information, and confirms predetermined shipping dates, to give our customers product delivery they can rely on.

Sales And Customer Service

Because we are a U.S.A. based company with modern manufacturing systems and facilities, turnaround time on orders is fast. A worldwide network of luthiers, equipment manufacturers, custom installers, and repair specialists provide technical assistance and service for all Kahler® products. As a result, Kahler® customers are assured of quality, professional service and replacement parts throughout the world.

Kahler® maintains the most contemporary technology in computerized manufacturing systems.

Kahler®'s well equipped factory is capable of handling a wide range of metal processes including machining, powdered metal, injection molding and flow steel. Additional processes include electro plating and epoxy baked finishes. Together with computerized technology, Kahler® handles large volume production while maintaining a high level of quality.

Kahler® operates as one efficient machine. In its network, control over the flow of raw material to finished product is all "In House".

Kahler® team concept between R & D, Production, and Sales guarantees top quality Product and service to all Kahler® customers.

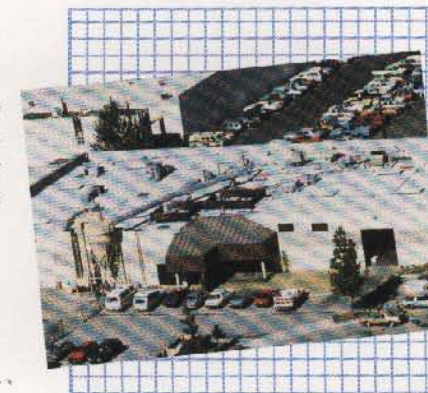

Kahler®/American Precision Metal Works

PO Box 9305, Anaheim, CA 92812
714-632-5280
Fax 714-632-9284

KAHLER KOLORS™

KAHLER® offers all of its products in seven brilliant, highly durable KAHLER KOLORS™

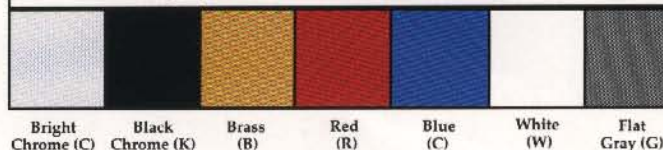

Kahler[®]
MADE IN USA

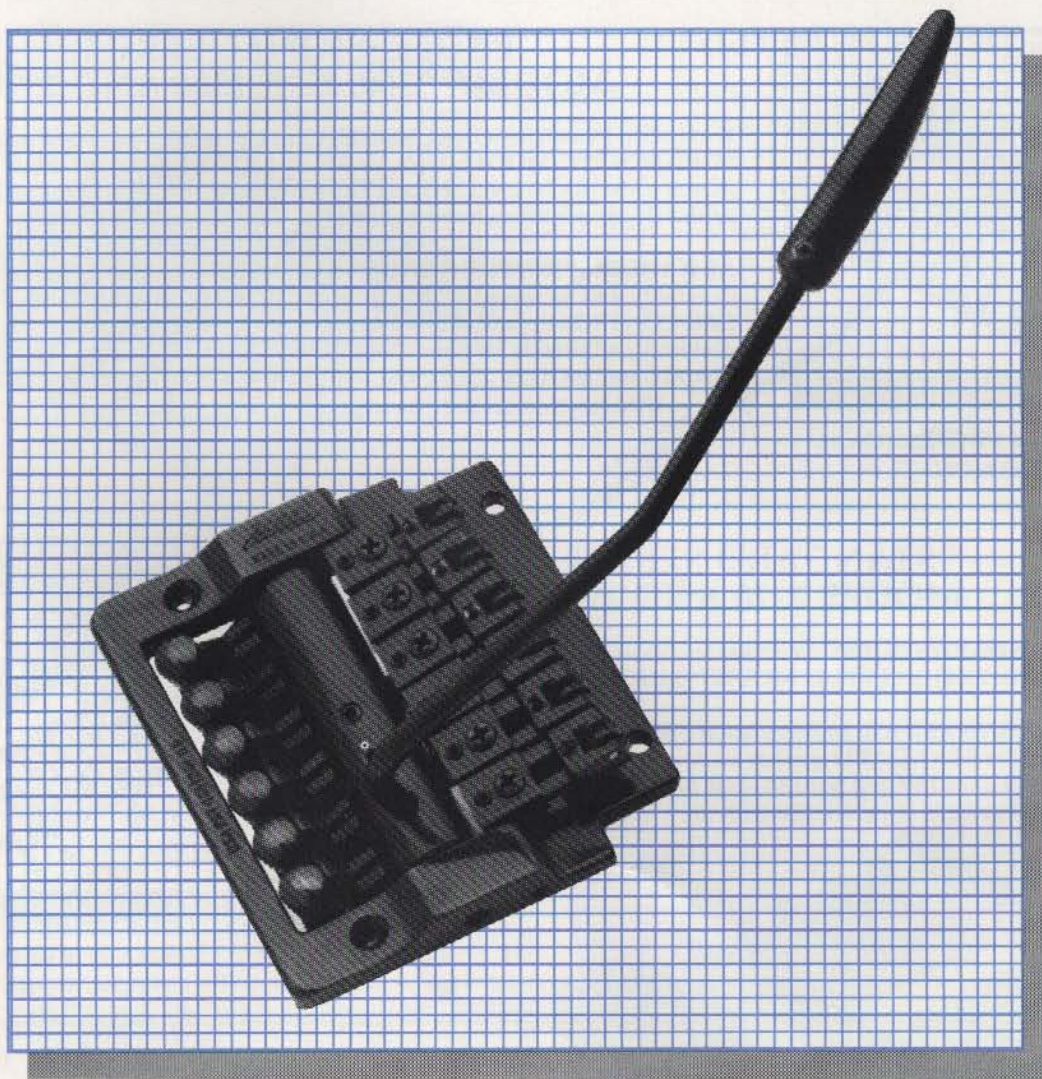

MODEL 2300 PROFESSIONAL FLAT MOUNT SYSTEM

KAHLER[®] CAM-OPERATED SYSTEMS

The **CAM-OPERATED TREMOLO BRIDGE SYSTEM** is often referred to as the 'original' **KAHLER[®]** system. Introduced in 1985, this patented **KAHLER[®]** design made history as the first widely accepted alternative to traditionally styled fulcrum tremolo bridge systems.

The Cam system is notable for its comfortable low profile and smooth, 'articulate' feel, making it a favorite among players who demand precise control over their tremolo effects.

KAHLER® CAM-OPERATED TREMOLO BRIDGE SYSTEMS

All KAHLER® CAM-OPERATED SYSTEMS are available with factory installed HEAVY DUTY SPRINGS and 1/4" Stainless Steel HEAVY DUTY ARMS upon request. The 'Heavy' option provides a more 'traditional' feel. Left-handed versions are available in all models.

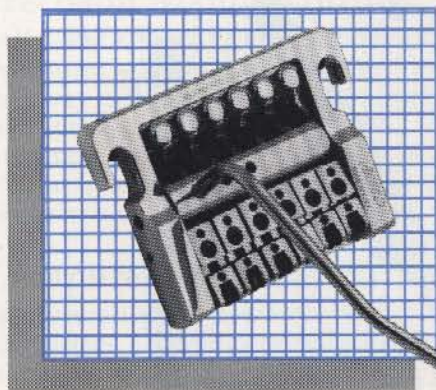

MODEL 2200 PROFESSIONAL
STUD MOUNT

PROFESSIONAL SERIES MODELS 2200, 2210, 2300 AND 2310

KAHLER® PROFESSIONAL SERIES Cam-Operated systems are available in either FLAT-MOUNT (MODEL 2300), or STUD-MOUNT (MODEL 2200) versions. Flat-mount units can be used on most flat-top guitars, while stud-mounts are designed primarily for use on arch-top guitars.

All KAHLER® PROFESSIONAL Bridges feature STEEL cams and roller saddles for durability and increased harmonic range, a PRO tremolo arm with adjustable FINGER-CONTROL tip, and a fully integrated cam/tuning cage assembly. Saddles are individually adjustable for height, intonation, and string spacing. MODEL 2310 (Flat Mount), and MODEL 2210 (Stud Mount) are also equipped with a PALM LEVER ARM for even greater versatility.

STANDARD SERIES MODEL 2220 AND 2320

KAHLER® STANDARD SERIES Cam-Operated systems are also available in FLAT-MOUNT (MODEL 2320), and STUD-MOUNT (MODEL 2220) versions.

STANDARD SERIES BRIDGE Systems feature BRASS cams and roller saddles for warm, rich tone. The STANDARD arm has a screw-on knob. Like all KAHLER® Cam Systems, Standard Flat and Stud Mounts have individually adjustable saddles, and are available upon request with the 'Heavy' spring/arm option.

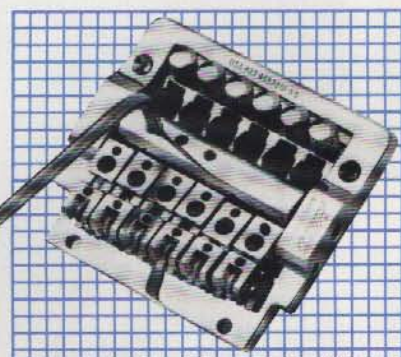

MODEL 2320 STANDARD
FLAT MOUNT

BASS TREMOLOS MODELS 2400, 2405, 2410 AND 2415

KAHLER® BASS TREMOLO BRIDGE SYSTEMS are also Cam-Operated devices with fully adjustable individual string saddles. Bass Tremolo bridges are available in two configurations: MODEL 2400 with rollers forward, and MODEL 2410 with rollers rearward for bass guitars with a limited fitting area (i.e. less than three inches from witness point to lower bout). Five-string versions are also available in both of these configurations (MODELS 2405 and 2415 respectively). Left-handed versions available in all models. Stringlock not required.

The KAHLER® BASS TREMOLO BRIDGE is a unique system, designed to help bass players expand their creative horizons from beyond the 'bottom' line.

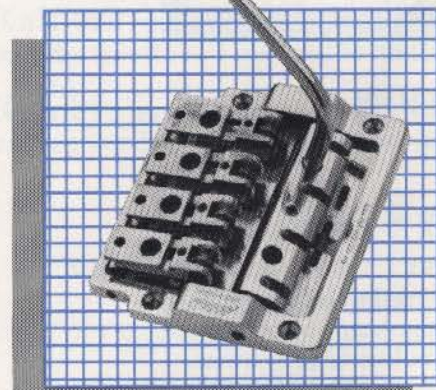

MODEL 2410 BASS TREMOLO

Kahler[®]
MADE IN USA

FIXED BASS BRIDGES

KAHLER's all NEW series of non-tremolo (fixed) Bass bridges combines simplicity of design with full adjustability. Height, intonation and string spacing adjustments allow bassists to set instruments up to their exact specifications. Available in four, five and six string versions, KAHLER's new non-tremolo bass bridges feature quick, easy string-up and great sustain.



MODEL 2440 FIXED BASS BRIDGE

KAHLER[®] FIXED SIX-STRING GUITAR BRIDGE

KAHLER[®] FIXED SIX-STRING GUITAR BRIDGES offer all the adjustability and comfort of KAHLER[®] tremolo bridges in a non-tremolo design. Easy installation and string-up, fine tuning, and individual saddle adjustments allow the player to customize action, string spacing and intonation to his or her personal preference. MODEL 3310 features Pro Series STEEL rollers and MODEL 3300 comes equipped with Standard Series BRASS rollers.

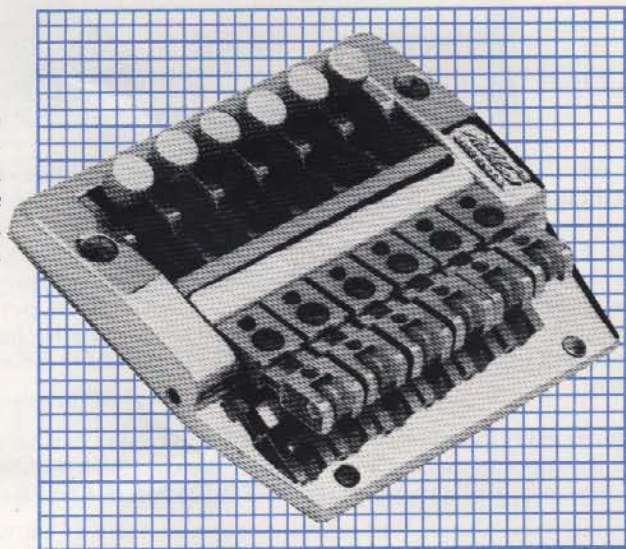

MODEL 3300 FIXED GUITAR BRIDGE

KAHLER® DOUBLE-LOCKING TREMOLOS*

Right and left hand versions are available in all models.

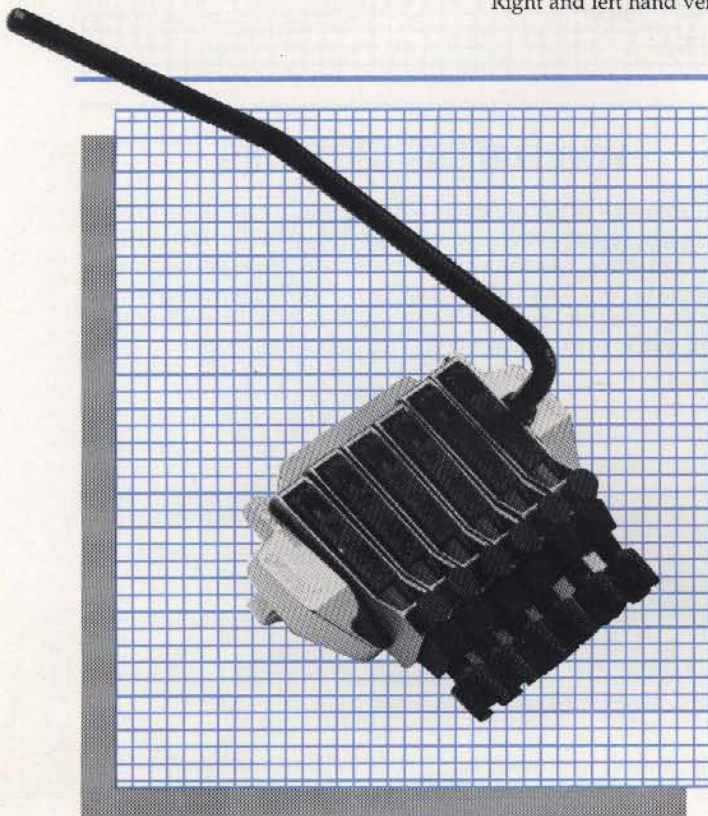

2700 SERIES™

KAHLER® 2700 SERIES™ BRIDGE SYSTEMS represent the most technically advanced fulcrum tremolo systems ever developed. Combining both KAHLER® and Floyd Rose patents, these double-locking systems offer sustain, playability, and durability unmatched by any other manufacturer.

KAHLER® DOUBLE-LOCKING SYSTEMS last longer and stay in tune better because of a patented hinging system which utilizes fulcrum KNIFE BOLTS. These bolts are guaranteed to stay sharp longer than plate knife edges found on other fulcrum tremolos.

MODEL 2710 DELUXE DOUBLE-LOCKING BRIDGE SYSTEMS offer truly professional features such as all STEEL construction for maximum sustain, fully adjustable locking saddles, and 'dial-in' intonation and radius capability. The unique FINGER-LOCKING saddles allow the player to lock strings tightly without the use of a wrench, and do not require cutting off the ball ends of strings.

Easily retrofittable to many of the world's most popular guitars, 2700 SERIES bridges are 'LATCH-READY', making them by far the most versatile and advanced piece of guitar hardware ever offered to guitarists.

MODEL 2710 DOUBLE-LOCKING TREMOLO

SPYDER™ SERIES DOUBLE-LOCKING TREMOLO BRIDGE SYSTEMS

The SPYDER™ is the newest arrival to the KAHLER® line of DOUBLE-LOCKING fulcrum style tremolo bridge systems. Available with your choice of WRENCH-LOCKING (MODEL 2722), FINGER-LOCKING (MODEL 2731), or NON-LOCKING (MODEL 2750) saddles, the SPYDER™ offers maximum sustain with STEEL WITNESS POINTS and KAHLER®'s patented knife bolt hinging system. Wider stud spacing allows for easy retrofit to many guitars. AUTO-LATCH™ capability on all models.

There are many 'licensed' systems on the market today, but only ONE is American-made. Only ONE has interchangeable saddle sets, and only ONE can accept the AUTO-Latch™...KAHLER®.

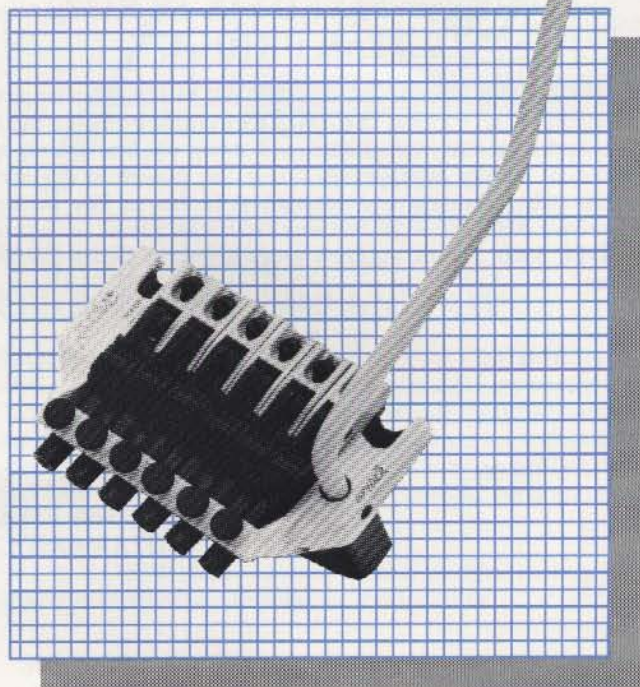

MODEL 2722 SPYDER™

*Licensed under Floyd Rose/David Petschulat Patents.

Kahler[®]
MADE IN USA

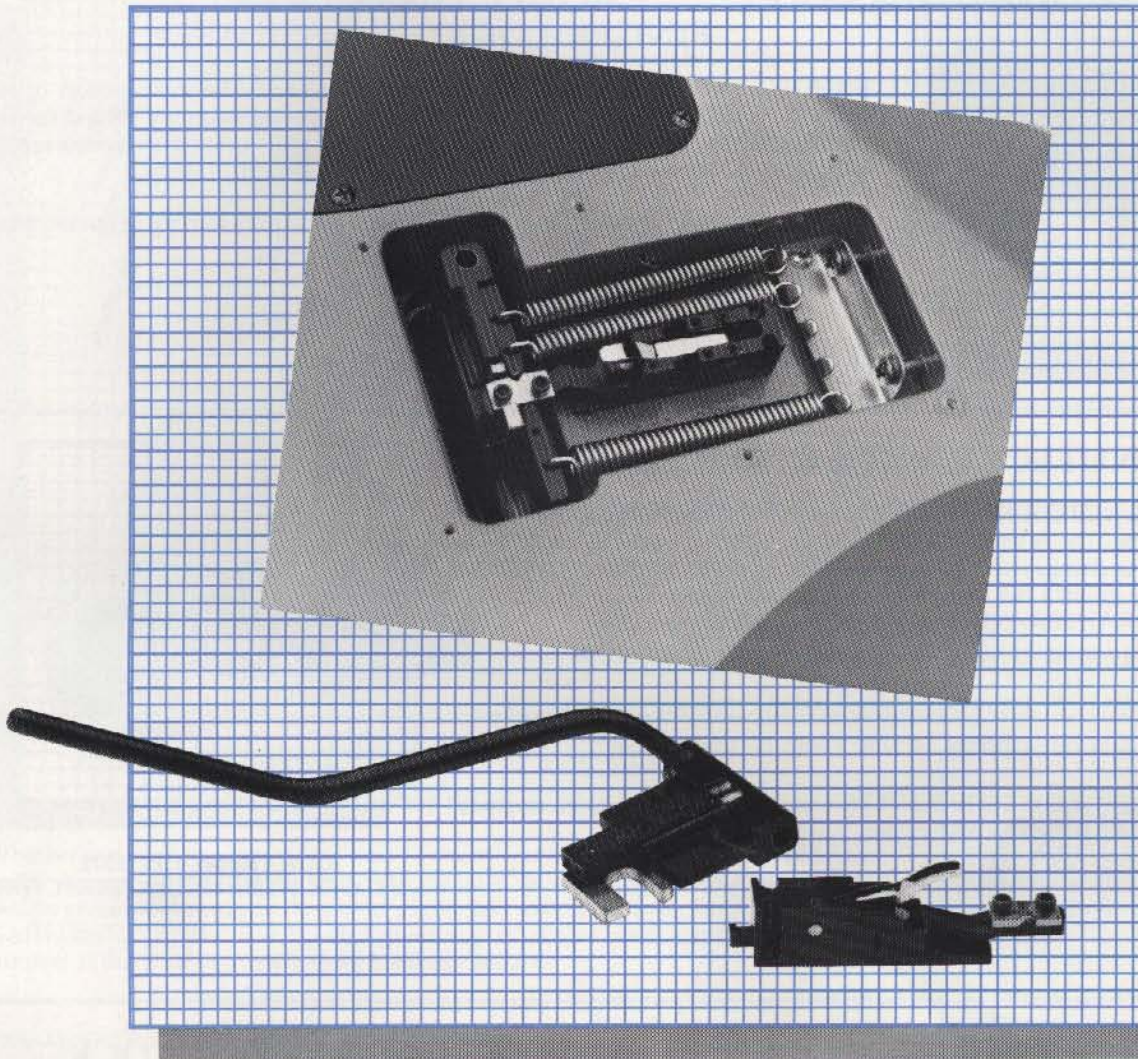

KAHLER[®] AUTO-LATCH[™] MODEL 5344-K1

KAHLER[®] AUTO-LATCH[™]

The KAHLER[®] AUTO-LATCH[™] is a tremolo position-lock device that allows you to mechanically transform any 2700 SERIES[™] or SPYDER[™] fulcrum tremolo bridge into a FIXED BRIDGE with just a flick of the wrist. Due to our unique INDEXING FUNCTION, tuning remains stable during palm-muting, string-bends or string breakage with the AUTO-LATCH[™] engaged. Disengage the AUTO-LATCH[™] and dive-bomb, pull sharp and create all the exciting sounds you've come to expect from a KAHLER[®] system. The AUTO-LATCH[™] is controlled by the tremolo arm, so it can be easily engaged and disengaged while playing. Also available for left-handed bridges.

KAHLER® TOP-LOCKING ASSEMBLIES

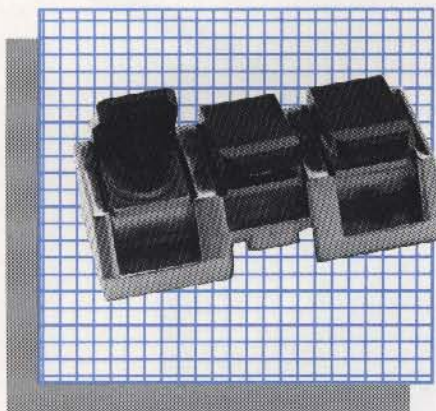

MODEL 5514 DELUXE FINGER-LOCKING ASSEMBLY

KAHLER® revolutionized top-locking mechanisms with the introduction of the **MODEL 5514 DELUXE STRINGLOCK**. Strings are locked securely behind the nut with finger-locking levers, eliminating the need for any tools. A unique slotted-wedge design provides even clamping to adjust for various gauges of strings.

Easy installation on virtually any guitar neck does not require routing or nut removal.

*MODEL 5514 DELUXE
FINGER-LOCKING STRINGLOCK*

KAHLER® NUTLOCK WITH STRING DIRECTOR

The new **KAHLER® NUTLOCK WITH STRING DIRECTOR** eliminates the need for a separate string-tree. The patented **STRING DIRECTOR** holds the string down on the locking surface so strings won't go sharp when clamped. **KAHLER® NUTLOCKS** actually replace the guitar's nut, but do not require drilling through the back of the neck to install. **KAHLER® NUTLOCKS** are available in three sizes:

Model 5511: 1.634" (approx. 1-5/8") with 12" radius.

Model 5521: 1.700" (approx. 1-11/16") with 12" radius.

Model 5522: 1.700" (approx. 1-11/16") with 17" (flat) radius.

With **KAHLER'S** new **SLOTTED TAB BOLTS**, (available separately as an upgrade) these nutlocks can *also* be locked with a coin.

(Some modifications may be necessary for use on left-handed system.)

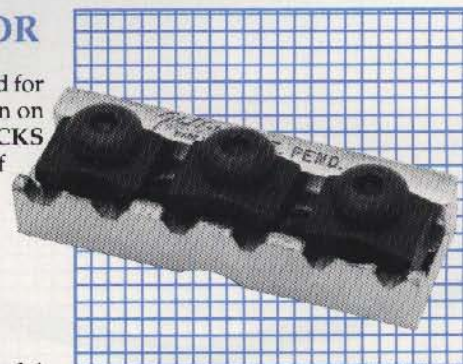

*KAHLER® MODEL 5521
NUTLOCK WITH STRING DIRECTOR*

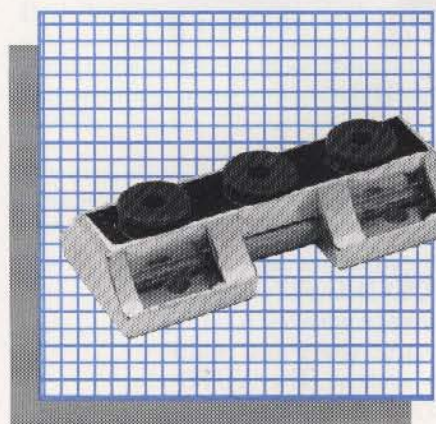

MODEL 5513 STANDARD STRINGLOCK

Commonly referred to as the 'original' **KAHLER®** Stringlock, the **MODEL 5513 STANDARD STRINGLOCK** remains an industry standard. Universal fit and easy installation makes this economically priced stringlock the favorite of guitarists the world over.

Since the strings are locked behind the nut, the player maintains control over string spacing, height and radius.

Strings are locked securely against steel inserts and easily adjusted with a wrench (provided with each unit).

MODEL 5513 STANDARD STRINGLOCK

KAHLER® ACCESSORIES

TREMOLO ARMS

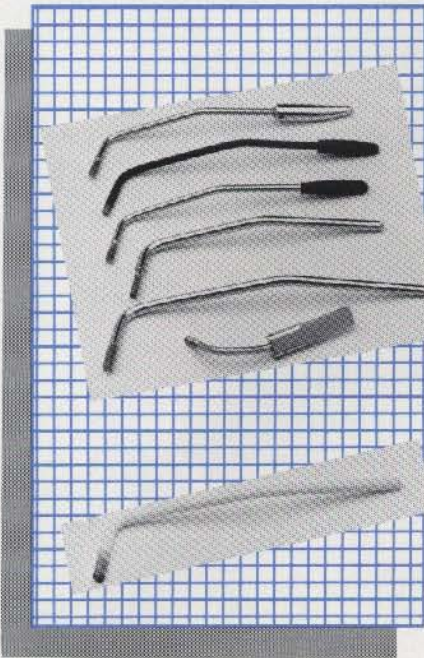

KAHLER® TREMOLO ARMS

KAHLER® continues to offer guitarists an ever increasing variety of choices when it comes to selecting or customizing a tremolo bridge system. Among these choices are eight different styles of tremolo arms. For Cam-Operated bridges, choose from:

MODEL 5360 Professional Tremolo Arm with comfort adjustable finger control tip.

MODEL 5362 Standard Tremolo Arm with traditional screw- on tip.

MODEL 5367 Flyer™ Tremolo Arm with plastic tip.

MODEL 8539 Heavy Duty 1/4" stainless steel tremolo arm without tip.

MODEL 8537 Bass Tremolo Arm without tip.

MODEL 5361 Pro Palm Lever with 'Spatula' tip.

MODEL 5366 Bass Palm Lever with 'Spatula' tip. (not pictured)

For Fulcrum Style and Double-Locking Systems:

MODEL 8530 Heavy Duty 1/4" Stainless Steel Fulcrum Arm.

KAHLER® Tremolo Arms are available in all Kolors except Brass.

KAHLER® REINFORCED ELECTRIC GUITAR STRINGS

Whether you play tremolo or not--today's electric guitar styles demand more of your guitar strings. At KAHLER®, we wrote the book on stressing strings. Our tremolo design gives more range to the guitar player and asks more from his strings. Now KAHLER® has created a string that gives you what you need--more strength and support at the winding where most breakage occurs.

	1	2	3	4	5	6
7000-XL EXTRA LIGHT	.009	.011	.016	.024	.032	.042
7200-L LIGHT	.010	.013	.017	.026	.036	.046

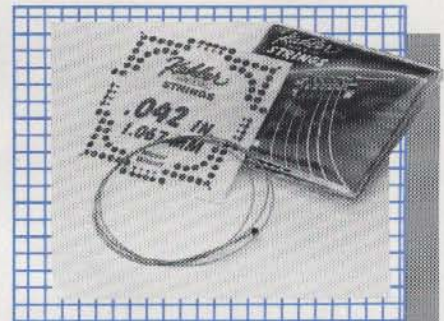

KAHLER® GUITAR STRINGS

KAHLER® UPGRADE KITS FOR CAM BRIDGES

Due to KAHLER'S advanced modular designs, all KAHLER® Cam-Operated bridges can be easily upgraded with a KAHLER® UPGRADE KIT. Kits contain cams and complete roller saddle sets. **MODEL 5620** upgrades from FLYERS™ to STANDARD. **MODELS 5630 and 5650** upgrade FLYERS™ to PRO SERIES (one and two arm versions respectively), and **MODELS 5600 and 5610** upgrade STANDARD bridges to PROFESSIONAL SERIES (one and two arm versions respectively).

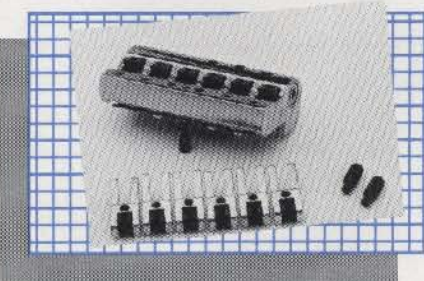

KAHLER® UPGRADE KITS

KAHLER® ACCESSORIES

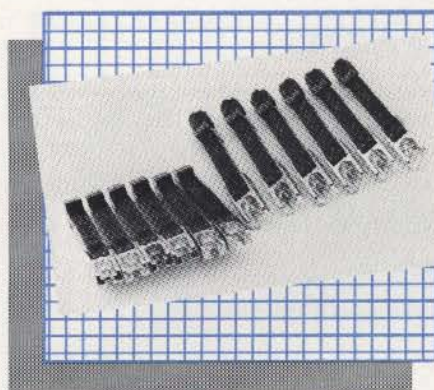

REPLACEMENT SADDLE SETS FOR FULCRUM STYLE BRIDGES

KAHLER® FULLY-MODULAR fulcrum tremolo bridge systems feature INTER-CHANGEABLE COMPONENTS to make upgrading easy. Choose from: **A) FINGER-LOCKING/MODEL 5338-1** saddle sets which eliminate the need for a wrench to lock strings at the bridge while allowing you to keep the ball-ends of strings intact, **B) WRENCH-LOCKING/MODEL 5582-1** saddles to economically upgrade your non-locking bridge, or **C) NON-LOCKING/MODEL 5344-1** saddle sets, for players whose style does not require locking at the bridge.

KAHLER® REPLACEMENT SADDLE SETS FOR FULCRUM STYLE BRIDGES

'HEAVY KIT'

MODEL 5347-HH1 'HEAVY' KIT contains two KAHLER® heavy duty springs, 1/4" stainless steel Heavy Arm and mounting hardware to convert any KAHLER® cam-operated bridge to a heavier, more 'traditional' feel.



MODEL 5347-HH1

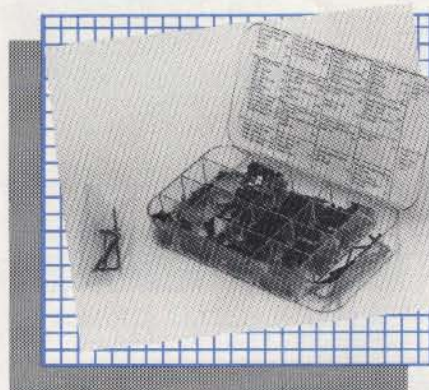

KAHLER® DELUXE REPAIR KIT

The KAHLER® DELUXE REPAIR KIT contains all of the most commonly lost, stolen and abused replacement parts for virtually every KAHLER system manufactured. KAHLER® believes in strong after market support of its dealers and consumers and realizes how frustrating it can be to locate small, yet vital replacement parts, especially from foreign manufacturers. With over 10,000 KAHLER® systems currently in use and with many of the world's most prestigious guitar manufacturers using KAHLER® as original equipment, the KAHLER® DELUXE REPAIR KIT is a valuable tool for any professional retailer or service technician.

MODEL 5670-1 REPAIR KIT

STRINGLOCK ACCESSORY KIT

The KAHLER® STRINGLOCK ACCESSORY KIT /MODEL 8475-U1 contains a round bottom shim for scoop style headstocks, a bullet truss rod adjustment converter and a spacing washer for mounting KAHLER® stringlocks onto guitars with bullet style truss rod adjustments.

KAHLER® REPLACEMENT PARTS are available for every KAHLER® bridge and accessory manufactured. Contact KAHLER® for a detailed replacement parts catalog and order form.

2710
*Double
Locking
Tremolo*



Four Stars For Kahler®

Ronnie Montrose
"Ronnie Montrose"
Fender Stratocaster
Kahler® 2710

"I've been using KAHLEERS® for five years ... And now with the release of the 2700 Series multi-artist have more choices than ever to use the finest bridges made."



Steve Lynch
"Autograph"
Jackson Soloist
Kahler® 2300
Pro Flat Mount

"The KAHLER® system is simple, stays in perfect tune, and gives me all the sustain I need. That is why it is the ONLY tremolo system I use."



Wolf Marshall
"Wolf Marshall"
Fender HM Strat
Kahler® Spyder

"The new KAHLER® Spyder tremolo system maintains accurate tuning even under extreme whammy bar abuse. The modular upgrade possibilities are inspiring ... The adjustments are well designed ... quick, hassle-free and easy to perform ... lets you concentrate on the music and being creative."



Craig Chacique
"Starship"
Carvin DC 125

Kahler® Spyder with Auto Latch
"I've used KAHLEERS® for years in the studio and on the road. The AUTO-LATCH® feature is a great addition to an already great mechanism ... A long overdue invention for those of us who like to use other playing techniques besides the basic whammy bar stuff. Thank you, KAHLEERS!"



Kahler®
MADE IN USA
BRIDGE SYSTEMS